

- A – Mating Ring (outer)
- B – Insert (outer)
- C – Pumping Ring
- D – Bellows Assembly (outer)
- E – Mating Ring (inner)
- F – Insert (inner)
- G – Flexible Carbon Graphite
- H – Bellows Assembly (inner)
- I – Spiral Wound Gasket

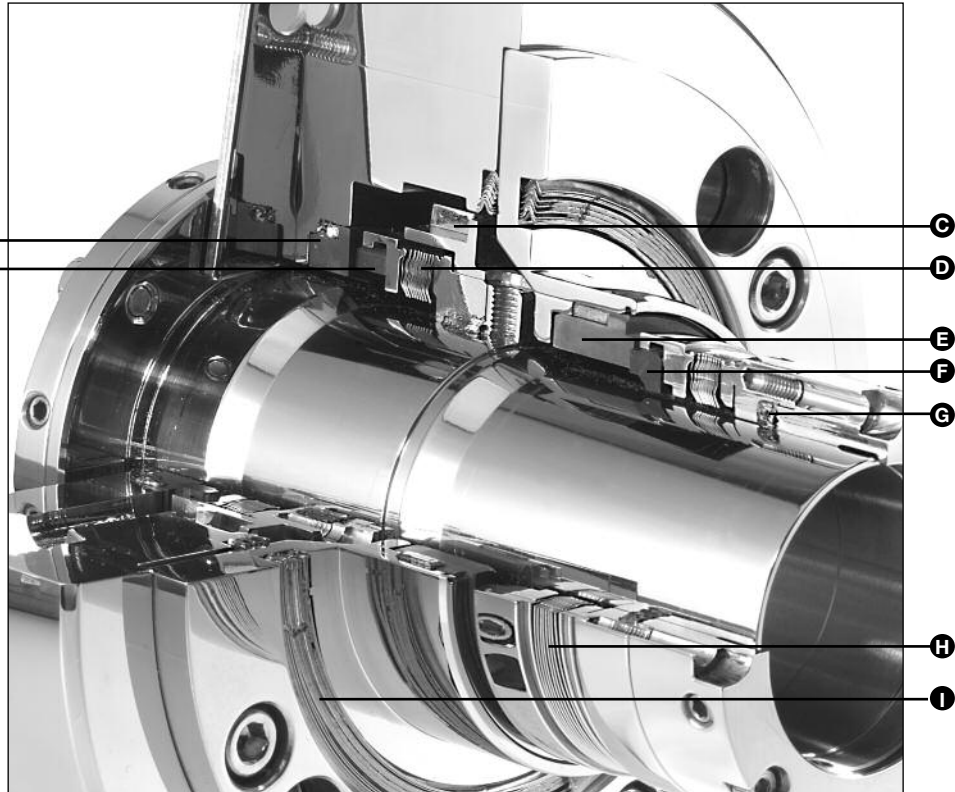

Welded Metal Bellows

### Product Description

High Temperature Bellows Seals that withstand temperatures up to 425°C/800°F

- Single and dual arrangements
- Edge-welded metal bellows
- Optimum seal arrangements for high temperature heat transfer fluids

### Design Features

- Fits pumps that are packed or sealed
- Easy-to-install cartridge design
- Only one moving part, the bellows
- Flexible graphite packings - no thermal degradation of the secondary packing
- Available with silicon carbide or tungsten carbide face for carbonizing heat transfer fluids
- Integral pumping ring for dual arrangements - no thermo-siphoning or expensive auxiliary pumping system

### Performance Capabilities

- Temperature: -75°C to +425°C/-100°F to +800°F
- Pressure: up to 20 bar g/300 psig
- Speed: up to 25 m/s / 5000 fpm
- End play/axial float allowance: 0.13mm/0.005" FIM max.
- Runout/out of squareness: 0.001mm/0.001" FIM max. per mm/inch of shaft diameter.

# TYPE 2715T/609

## SINGLE/DUAL CARTRIDGE, METAL BELLOWS SEALS

Technical Specification

### Type 2715T Typical Arrangement

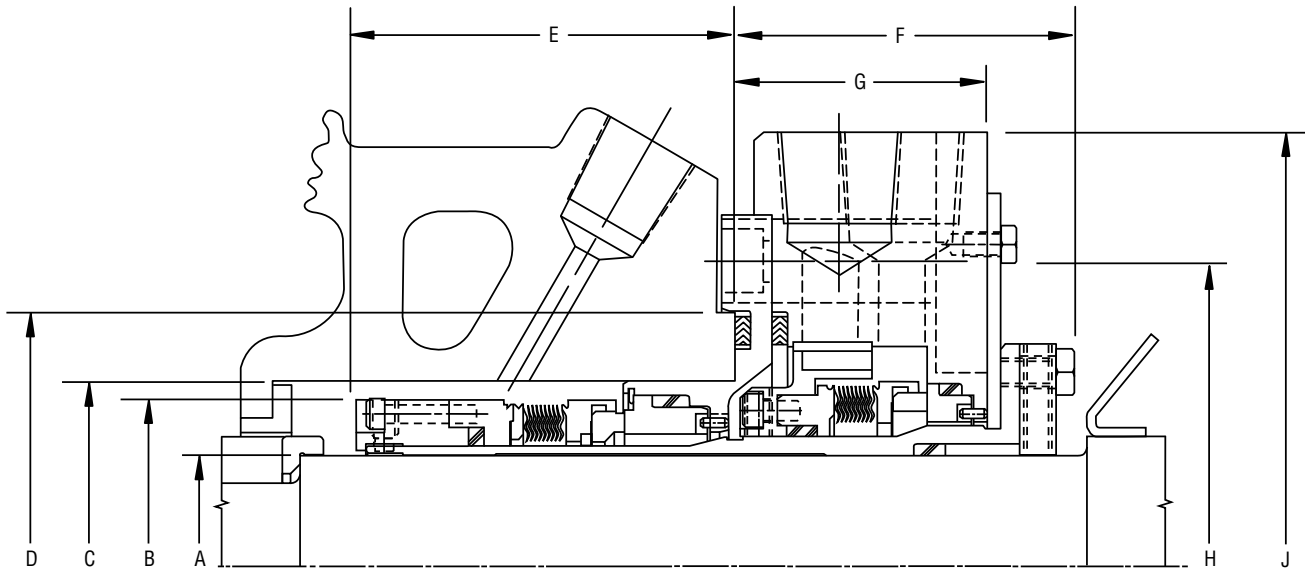

### Type 2715T Dimensional Data (inches)

Cartridge Seal Size* (inches)	Dean Pump Model	A +0.00/-0.05mm +0.000/-0.002"	B	C +0.05/-0.00mm +0.002/-0.000"	D +0.00/-0.08mm +0.000/-0.003"	E	F	G	H (Bolt Circle)	J
1.500	R434	1.499	2.250	2.500	3.437	2.724	2.293	1.703	4.125	5.875
2.000	R454	1.999	2.875	3.250	4.500	2.632	2.675	1.957	5.500	6.750
2.686	R484	2.686	3.812	4.000	5.500	2.840	2.831	2.082	6.625	8.000

\*Cartridge seal size equals solid shaft or pump sleeve OD.

# TYPE 2715T/609

## SINGLE/DUAL CARTRIDGE, METAL BELLOWS SEALS

### Type 609 Typical Arrangement

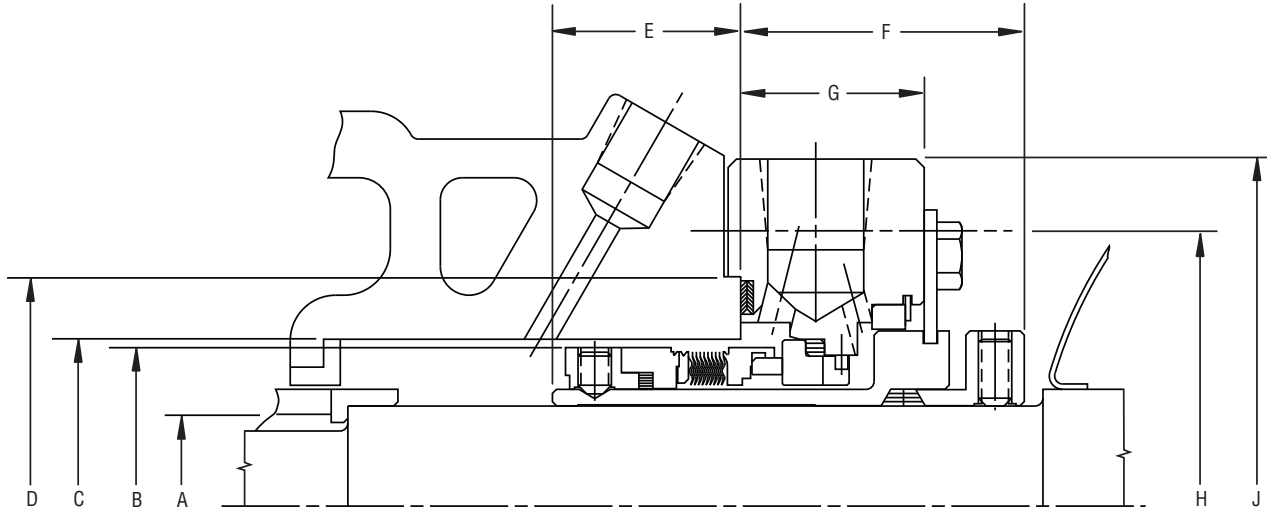

### Type 609 Dimensional Data (inches)

Cartridge Seal Size* (inches)	Dean Pump Model	A		C		D		E	F	G	H (Bolt Circle)	J
		+0.00/-0.03mm +0.000/-0.001"	B	+0.05/-0.00mm +0.002/-0.000"	+0.00/-0.08mm +0.000/-0.003"							
1.500	R434	1.499	2.375	2.500	3.437	1.438	2.130	1.375	4.125	5.250		
1.750	R434**	1.750	2.625	3.500	4.250	1.559	2.070	1.312	5.500	6.950		
1.875	R444	1.874	2.750	2.875	4.000	1.500	2.220	1.188	4.875	6.125		
2.125	R444**	2.125	3.000	3.875	4.625	1.594	2.160	1.312	5.875	6.950		
2.000	R454	1.999	2.875	3.250	4.500	1.438	2.690	1.313	5.500	6.500		
2.250	R454**	2.250	3.250	4.250	5.250	1.538	2.590	1.438	6.875	8.250		
2.686	R484	2.686	3.812	4.000	5.500	1.375	3.190	1.813	6.625	8.000		
3.000	R484**	3.000	4.125	5.000	6.000	1.875	2.870	1.500	7.625	8.950		

\* Cartridge seal size equals solid shaft or pump sleeve OD.

\*\* Oversize bore version.

# TYPE 2715T/609

## SINGLE/DUAL CARTRIDGE, METAL BELLOWS SEALS

### Basic Pressure Rating

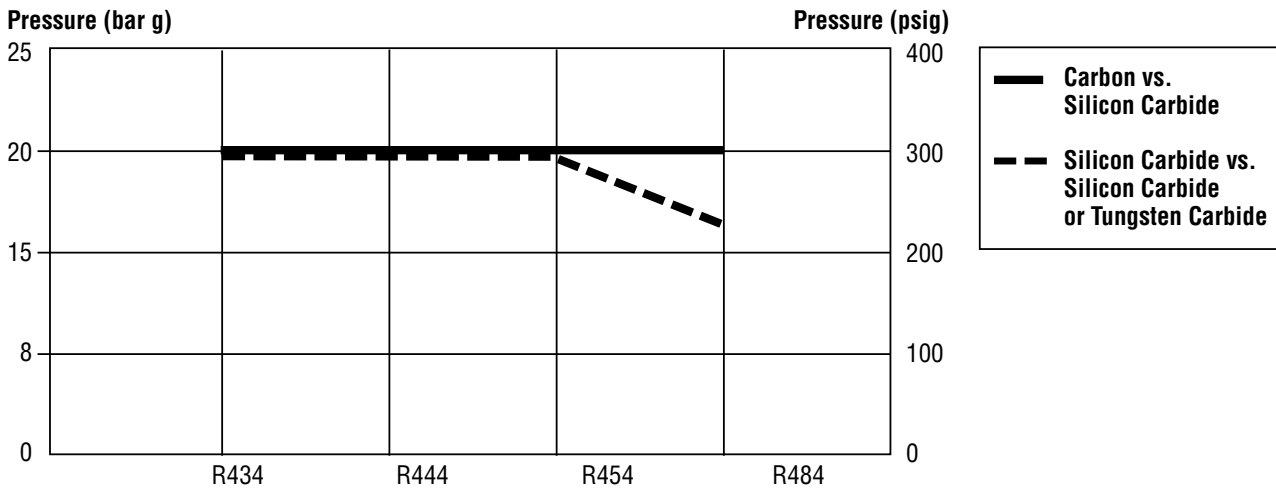

#### Dean Bros. Pump Model

The basic pressure rating is for a standard seal, as shown in the typical arrangement, when installed according to the criteria given in this data sheet and generally accepted industrial practices.

The basic pressure rating assumes stable operation at 1800 rpm in a clean, cool, lubricating, nonvolatile liquid with an adequate flush rate. When used with the multiplier factors, the basic pressure rating can be adjusted to provide a conservative estimate of the dynamic pressure rating. For process services outside this range or a more accurate assessment of the dynamic pressure rating, contact John Crane for more information.

### Multiplier Factors

	Selection Considerations	Multiplier Factor	
		Carbon vs. SiC	SiC vs. SiC
<b>Speed</b>	Up to 3600 rpm Above 3600 rpm	x 1.00 x (3600/speed)	x 1.00 x (3600/speed)
<b>Sealed Fluid Lubricity</b>	Petrol/Gasoline, Kerosene, Lube Oil, etc... Water and Aqueous Solutions (<80°C/176°F) Light Hydrocarbons (see note 1)	x 1.00 x 0.75 x 0.60	x 1.00 x 0.75 (see note 2)
<b>Sealed Fluid Temperature</b> (see note 3)	Up to 80°C/176°F Up to 120°C/250°F Up to 205°C/400°F Up to 315°C/600°F Above 315°C/600°F	x 1.00 x 0.90 x 0.80 x 0.65 x 0.65	x 1.00 x 1.00 x 1.00 x 1.00 (see note 4)

#### NOTES:

- Specific gravity  $\geq 0.6$  and ratio of sealed pressure to vapor pressure  $\geq 1.50$ .
- More details regarding the fluid and the operating conditions are required.
- Temperature at the seal faces includes effects of flush quench and cooling.
- Contact John Crane for more information.

#### Example for Determining Dynamic Pressure Rating Limits:

Seal: Type 609 single Cartridge Seal, R434 pump model, 1.500" cartridge size

Product: Dowtherm® G

Face material: carbon vs. silicon carbide

Temperature: 320°C/610°F

Speed: 3600 rpm

Find the maximum operating pressure for the applications.

$$20 \text{ bar g}/300 \text{ psig} \times 1.00 \times 1.00 \times 0.65 = 13 \text{ bar g}/195 \text{ psig}$$

At 3600 rpm with the service conditions noted, a 1.500" cartridge size.

Type 609 Seal has a maximum operating pressure limit of 13 bar g/195 psig.

### Piping Recommendations for Single Arrangements

**API Plan 02 (ANSI Plan 7302) Dead-ended Seal Chamber with No Circulation of Flushed Fluid.**

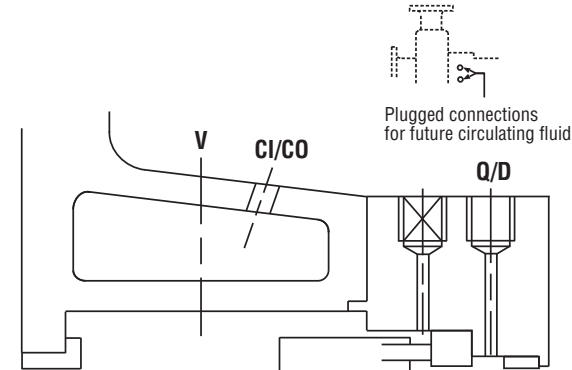

Dean Pump Co. pumps are usually fitted with a jacketed seal chamber. Ensure cooling water is provided to the seal chamber jacket to reduce product temperature and improve its lubricating properties in the area around the seal. Do not recirculate product if a cooling jacket is used, as this will defeat the cooling effect.

**API Plan 62 (ANSI Plan 7362) External Fluid Quench (steam).**

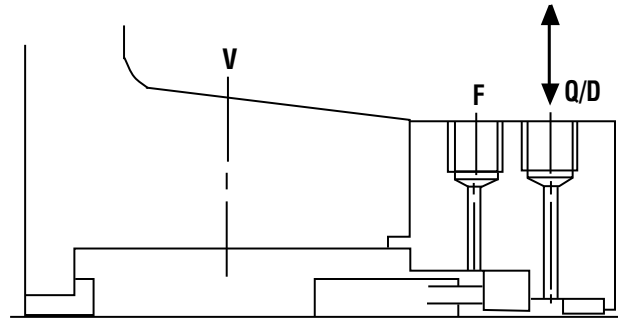

A steam quench will substantially increase the operating life of the seal. Ensure that the gland plate is installed with the DRAIN OUT (DO) connection at the lowest point possible to prevent trapping condensate in the gland cavity. Pipe to a suitable drain/recovery system. Supply 2-3 psi dry steam to the quench connection at the top of the gland and ensure that the steam line is always OPEN during operation.

### Piping Recommendations for Dual Arrangements

**API Plan 52 (ANSI Plan 7352) non-pressurized external fluid reservoir with forced circulation**

Pipe from the top of the reservoir through an orifice to an environmentally suitable vapor recovery system. Install high pressure and high/low level alarms to signal failure of either the inner or outer seal.

**API Plan 53 (ANSI Plan 7353) pressurized external fluid reservoir with forced circulation**

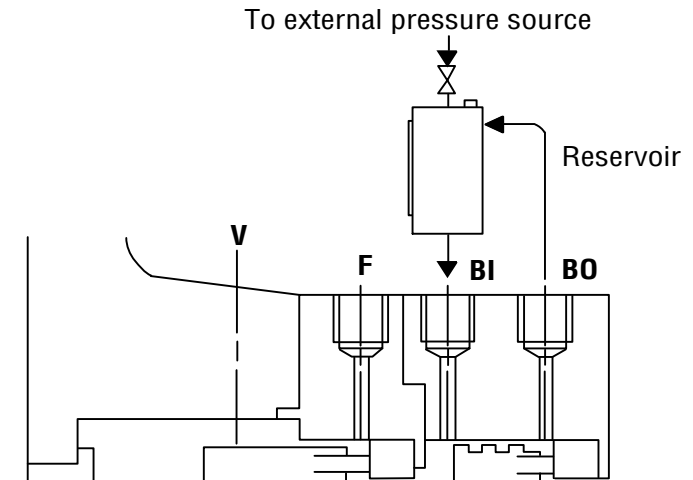

Pipe nitrogen to the top of the reservoir at 10% above the maximum seal chamber pressure (minimum 2 bar/25 psi, maximum 10 bar/150 psi). Install low pressure and high/low level alarms to signal failure of either the inner or outer seal.

Maintain the liquid level at least 30mm/1.00" above the return piping connection. Check the barrier/buffer fluid regularly for contamination, and replace as necessary.

# TYPE 2715T/609

## SINGLE/DUAL CARTRIDGE, METAL BELLOWS SEALS

Technical Specification

### Materials of Construction

SEAL COMPONENTS	MATERIALS	
	Description	Options
Insert	Carbon	Silicon Carbide Reaction Bonded Tungsten Carbide Nickel Bound
Seat/Mating Ring	Silicon Carbide Reaction Bonded	—
Adaptive Hardware	300 Series Stainless Steel	—
Bellows	Alloy 718 (UNS N07718)	—
Shell	Alloy 42 (UNS K94100)	—
Adapter	Alloy 625 (UNS N06625)	—
Static Seals	Flexible Carbon Graphite	—

john crane

# TYPE 2715T/609

SINGLE/DUAL CARTRIDGE, METAL BELLOWS SEALS

Technical Specification

Dowtherm G is a registered trademark of Dow Chemical Company.



North America	Europe	Latin America	Middle East & Africa	Asia Pacific
United States of America	United Kingdom	Brazil	United Arab Emirates	Singapore
Tel: 1-847-967-2400	Tel: 44-1753-224000	Tel: 55-11-3371-2500	Tel: 971-481-27800	Tel: 65-6518-1800
Fax: 1-847-967-3915	Fax: 44-1753-224224	Fax: 55-11-3371-2599	Fax: 971-488-62830	Fax: 65-6518-1803

If the products featured will be used in a potentially dangerous and/or hazardous process, your John Crane representative should be consulted prior to their selection and use. In the interest of continuous development, John Crane Companies reserve the right to alter designs and specifications without prior notice. It is dangerous to smoke while handling products made from PTFE. Old and new PTFE products must not be incinerated. ISO 9001 and ISO14001 Certified, details available on request.